

LAVAMANI OVALE-TRAPEZIOIDALE-SEMISFERICO
OVAL-TRAPEZOIDAL-SEMISPHERE WASH BASIN

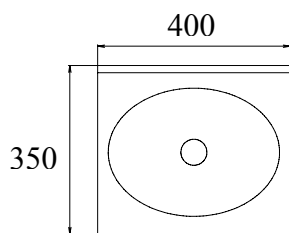
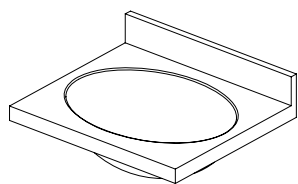

Misura impronta: 355 x 265 h 125

Printed size: 355 x 265 h 125

LAVAMANI OVALE / OVAL WASH BASIN

N. riferimento/No. reference: 400 x 350 Bordo/edge h30

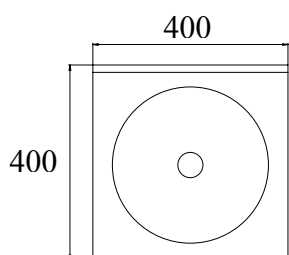
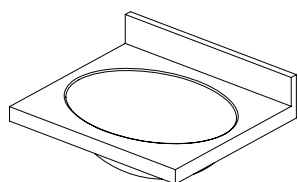

Misura impronta: ϕ 320 x h 125

Printed size: ϕ 320 x h 125

LAVAMANI TONDO / ROUND WASH BASIN

N. riferimento/No. reference: 400 x 400 Bordo/edge h30

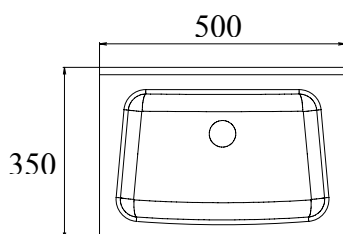
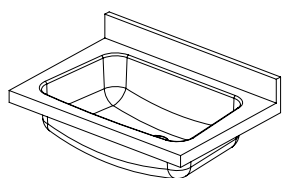

Misura impronta: 430 x 260 h 125

Printed size: 430 x 260 h 125

**LAVAMANI TRAPEZIOIDALE/
TRAPEZOIDAL WASH BASIN**

N. riferimento/No. reference: 500 x 350 Bordo/edge h 30

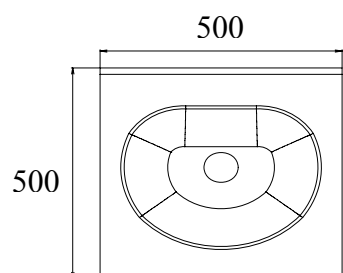
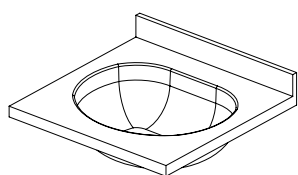

Misura impronta: 415 x 340 h 125

Printed size: 415 x 340 h 125

**LAVAMANI SEMISFERICO/
SEMISPHERE WASH BASIN**

N. riferimento/No. reference: 500 x 500 Bordo/edge h30

LAVAMANI OVALE-TRAPEZIOIDALE-SEMISFERICO
OVAL-TRAPEZOIDAL-SEMISPHERE WASH BASIN

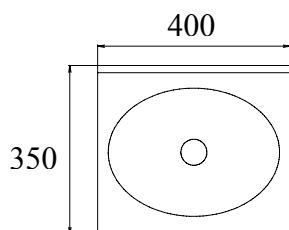
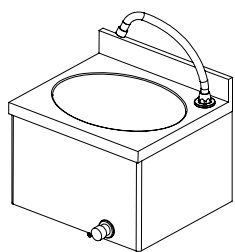

LAVAMANI OVALE PANNELLATO /
OVAL WASH BASIN-PANNELED

N. riferimento/No. reference: 400 x 350 fascia/band h 280

Misura impronta: 355 x 265 h 125

Printed size: 355 x 265 h 125

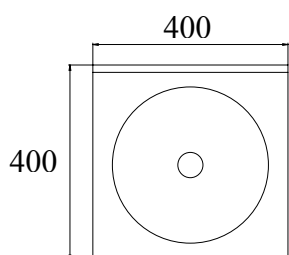
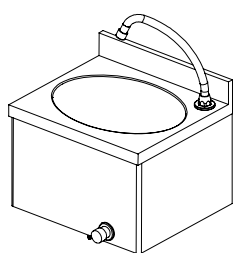

LAVAMANI TONDO PANNELLATO /
ROUND WASH BASIN - PANNELED

N. riferimento/No. reference: 400 x 400 fascia/band h 280

Misura impronta: ϕ 320 x h 125

Printed size: ϕ 320 x h 125

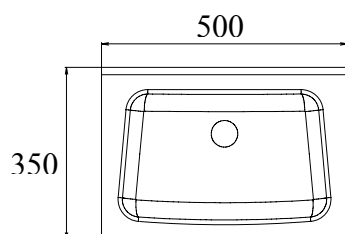
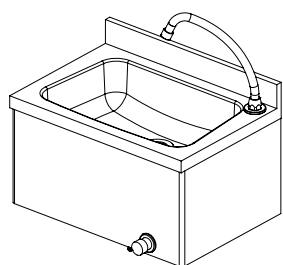

LAVAMANI TRAPEZOIDALE PANNELLATO/
TRAPEZOIDAL WASH BASIN - PANNELED

N. riferimento/No. reference: 500 x 350 fascia/band h 280

Misura impronta: 430 x 260 h 125

Printed size: 430 x 260 h 125

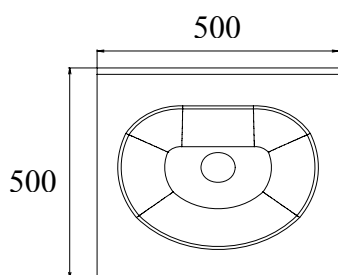
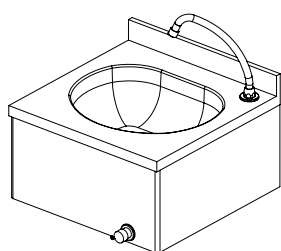

LAVAMANI SEMISFERICO PANNELLATO/
SEMISPHERE WASH BASIN - PANNELED

N. riferimento/No. reference: 500 x 500 fascia/band h 280

Misura impronta: 415 x 340 h 125

Printed size: 415 x 340 h 125

LAVAMANI OVALE-TRAPEZIOIDALE-SEMISFERICO
OVAL-TRAPEZOIDAL-SEMISPHERE WASH BASIN

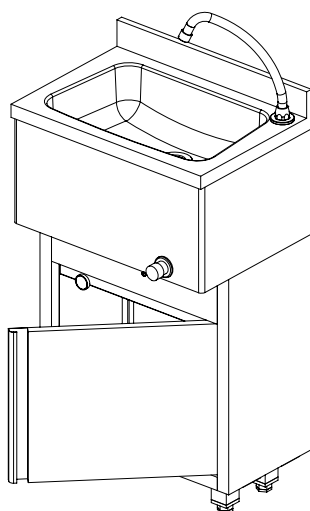

**LAVAMANI TRAPEZOIDALE CON MOBILE/
TRAPEZOIDAL WASH BASIN WITH CABINET**

N. riferimento/No. reference: 500 x 350 h 850

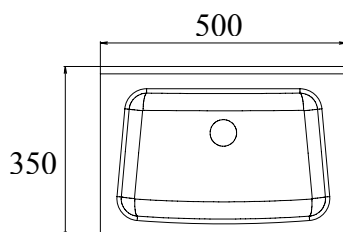

Misura impronta: 430 x 260 h 125
Printed size: 430 x 260 h 125

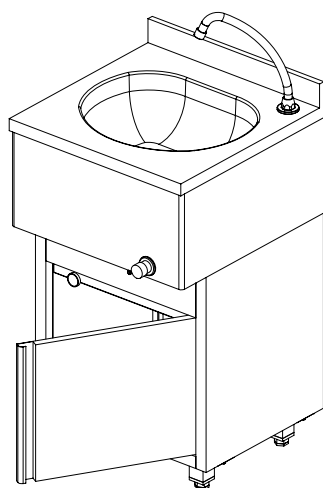

**LAVAMANI SEMISFERICO CON MOBILE/
SEMISPHERE WASH BASIN WITH CABINET**

N. riferimento/No. reference: 500 x 500 h 850

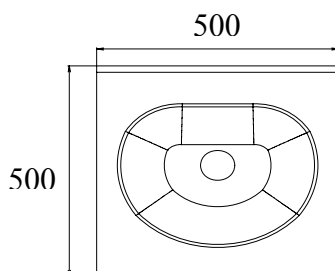

Misura impronta: 415 x 340 h 125
Printed size: 415 x 340 h 125